

Varenummer: 201631B402SW
Beskrivelse: E+G Flange lineærenhed
GN163.1-B40-2-SW

Mål

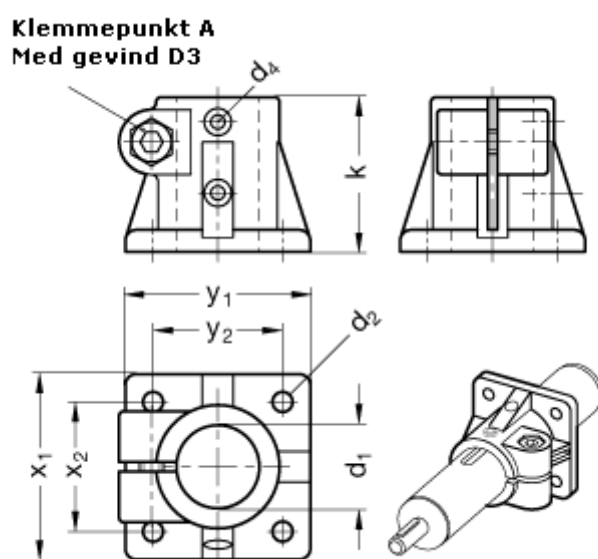

$d_1 = B40$	$y_2 = 64$
$d_2 = 8,5$	
$d_3 = M10$	
$d_4 = M 5$	
$k = 70$	
$x_1 = 90$	
$x_2 = 64$	
$y_1 = 90$	